

# ALL-NEW L200

---

  
**MITSUBISHI  
MOTORS**  
Drive your Ambition



# POWER FOR ADVENTURE

Experience the next level of toughness with the all-new L200 Series 7. Its advanced engineering and ultra-tough features redefine the reliability and ruggedness of pickups. Get ready for a new adventure and lifestyle with the L200.



# POWERFUL, CONFIDENT AND OUT THERE



**2.4L**  
TURBO DIESEL ENGINE

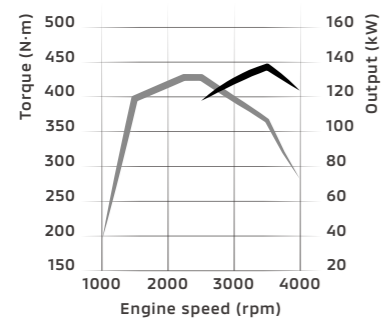

## New 2.4L Turbo Diesel Engine

Experience powerful acceleration and responsive performance with 150kW power and 470N·m torque.



# DISCOVER ADVENTURE ON ANY ROAD

Go anywhere with best-in-class off-road performance, honed through rigorous testing and rallies in harsh conditions all around the world.



## Super Select 4WD-II

Mitsubishi Motors' one and only Super Select 4WD-II system provides exceptional all-terrain performance with its four selectable modes, including 4H (full-time 4WD) that delivers great stability even on wet surfaces, and outstanding cornering performance even on dry pavement.

	<b>2H</b> 2WD		<b>4H</b> Full-time 4WD
	<b>4HLc</b> Centre Diff Locked 4WD		<b>4LLc</b> Low Gear Centre Diff Locked 4WD

## DRIVE MODE

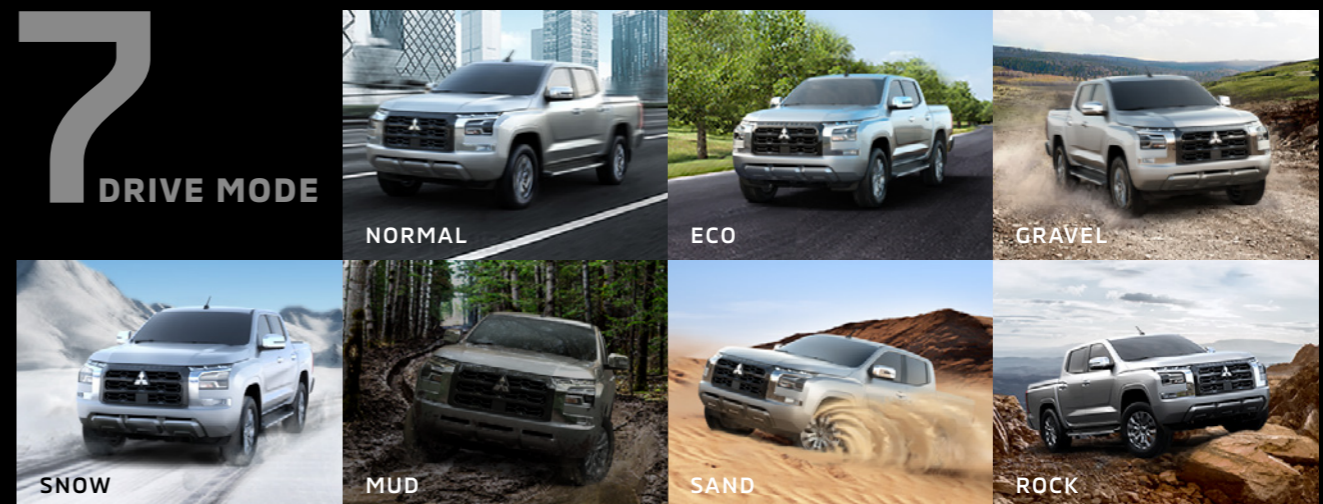

# TOTAL CONFIDENCE

## FROM TOTAL CONTROL



### Active Yaw Control [AYC]

The AYC system helps you precisely handle slippery roads with gravel and snow, turning the L200 just as you want – an exciting driving experience for those who enjoy sporty or off-road driving.

### Active Stability and Traction Control [ASTC]

ASTC applies brake force whilst cornering to maintain vehicle stability and optimise traction to prevent torque loss. The system adjusts engine output and applies brake force to spinning wheels as needed.

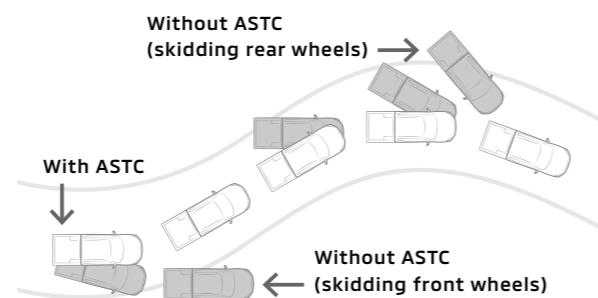

### Active Limited Slip Differential (Brake Control Type)

Helps prevent wheel spin on slippery roads by applying brake force to spinning wheels, ensuring better control and road grip.

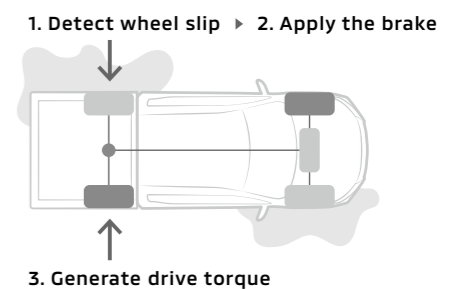

# FREEDOM TO EXPLORE THE NEXT FRONTIER



## Hill Start Assist [HSA]

HSA helps prevent rolling backward on steep slopes by maintaining braking force for up to two seconds after the brake is released. This helps ensure a safe start until the accelerator is applied.

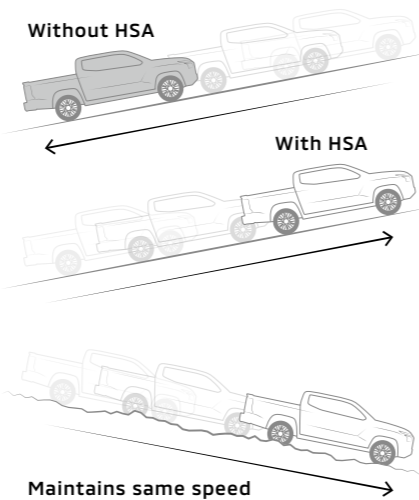

## Hill Descent Control [HDC]

HDC applies brakes and maintains speed when travelling downhill, for safer steering without manual brake application. Activates at 2-12 MPH.



# BUILT TO GO ANYWHERE



## New Chassis Frame

The chassis frame is built with high-tensile materials to withstand tough terrain and ensure reliable performance in any condition. It's the foundation of outstanding driving performance and ride comfort on any terrain.



## Completely Redesigned Suspension System

The completely redesigned front and rear suspension systems enhance driving performance and comfort by providing superior handling on various road types.



Front suspension



# EMPOWERS EVERY JOURNEY

The interior is designed for comfort during long trips, with advanced technology and a thoughtfully crafted living space that empowers you to enjoy your ride, no matter where your journey takes you.

## 9-inch Infotainment System

Enjoy a stress-free and enjoyable time in the vehicle with the intuitive and convenient 9-inch infotainment system that comes with smartphone connectivity and an easy-to-see display.

## Combination Meter

The new 7-inch multi-information display puts all the necessary information in front of you, allowing you to easily understand the vehicle's status at a glance. The new meter display also makes recognition effortless.



•MAPS •MUSIC •PHONE •Siri •MESSAGES •APPS  
 Note: Apple CarPlay is a trademark of Apple Inc., registered in the U.S. and other countries.  
 For more information: [www.apple.com/ios/carplay/](http://www.apple.com/ios/carplay/)



•MAPS •MUSIC •PHONE  
 •GOOGLE ASSISTANT •MESSAGES •APPS  
 Note: Google, Google Assistant, Android, Android Auto and other related marks are trademarks of Google LLC.  
 For more information: [www.android.com/auto/](http://www.android.com/auto/)



# MODERN INTERIOR FOR PROFESSIONALS

## User-Friendly Components

The interior is designed to enhance your driving experience with user-friendly components that are intuitive to use, with every detail crafted with your comfort and convenience in mind.



Easy-to-Grip and Comfortable Steering Wheel



Glove-Friendly and Intuitive Air Conditioning Switches

Soft-to-Touch and 3D-Shaped Intuitive Door Handles

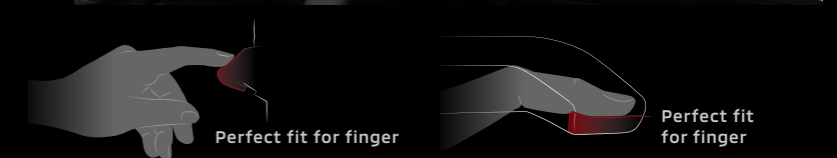

## Convenient Tech and Storage Solutions

Make your drive convenient and enjoyable with an interior equipped with tech and storage solutions. Stay organised with ample storage space for all your items.



Smartphone Wireless Charger

Rear USB Ports (A&C Type)

Upper Glove Box

# THE ULTIMATE WORKHORSE

THAT GETS THE JOB DONE



## Big and Practical Cargo Space

Easily carry all your essentials, including a Euro pallet, with the versatile cargo bed. It's designed to handle everything you need, and more.

## Practical Features



### Wide Side Step

Designed to provide slip-resistant footing for safe and easy entry and exit from the vehicle, even in wet or slippery conditions.

### Rear Bumper Corner Shape\*

The rear bumper corner allows for more foot space when the tailgate is open, and it has the largest step area in its segment.

\*Barbarian only

# PEACE OF MIND WITH ADVANCED SAFETY FEATURES



## Mitsubishi Motors Safety Sensing [MMSS]

Mitsubishi Motors offers advanced safety features through MMSS, giving our customers peace of mind during every adventure and ensuring a safe return home.

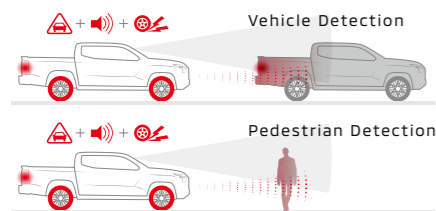

### Forward Collision Mitigation system [FCM]

FCM can help detect vehicles and pedestrians and alert the driver with audio and visual warnings, as well as apply the brakes to avoid or reduce potential collisions.

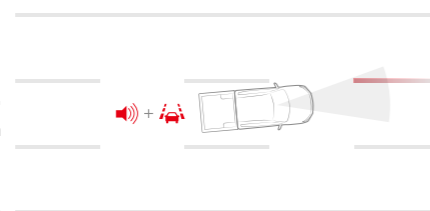

### Lane Departure Warning [LDW]

LDW warns the driver with visual and audible alerts when the vehicle unintentionally crosses lane markings at speeds over 40mph, using a windshield-mounted camera.

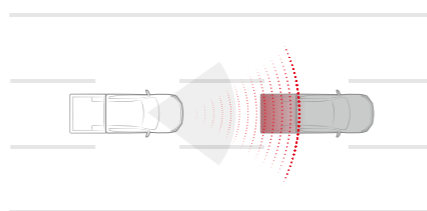

### Adaptive Cruise Control [ACC]

ACC uses advanced radar and camera technology to judge the distance to the vehicle ahead and automatically adjusts the vehicle's speed to maintain the set driving distance.

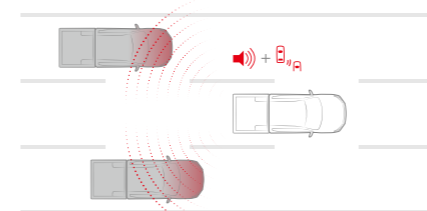

### Blind Spot Warning [BSW] with Lane Change Assist [LCA]

Rear bumper radar sensors detect vehicles in blind spots on both sides. If a vehicle is detected whilst the turn signal is on, an indicator blinks in the corresponding side mirror and a buzzer sounds.

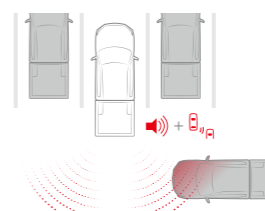

### Rear Cross Traffic Alert [RCTA]

When reversing, if radar sensors detect a moving vehicle, the system warns through visual, audible, and side mirror alerts, helping to enhance safety and prevent potential collisions.

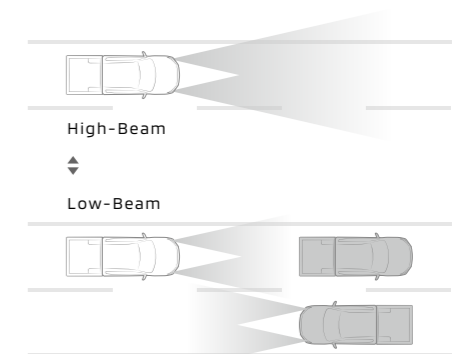

### Automatic High-Beam [AHB]

Automatically switches headlights between low and high beam based on the presence of a vehicle ahead for safer and more comfortable night-time driving.

Note: The radar wave graphics are for illustrative purposes only and do not represent the actual sensor application. Drivers are fully responsible for their own safe driving. Please drive safely and do not rely solely on these systems whilst driving. Some equipment may vary by market. Please consult your local MITSUBISHI MOTORS dealer for details.

MODELS

DOUBLE CAB  
**TITAN**

[ 4WD ] 6AT



DOUBLE CAB  
**BARBARIAN**

[ 4WD ] 6AT



Fabric



Leather

Note: Vehicles with genuine leather seats use synthetic leather for parts of the seat surface, sides, backside, headrest, rear centre armrest, and door trim fabric. Some equipment may vary by market. Please consult your local MITSUBISHI MOTORS dealer for details.

## BODY COLOURS



Yamabuki Orange [M14]



Graphite Grey [U28]



Blade Silver [U33]



Black [X37]



White [W19]



White Diamond [W85]

	Titan	Barbarian
Yamabuki Orange [M14]	-	■
Graphite Grey [U28]	■	■
Blade Silver [U33]	■	-
Black [X37]	-	■
White [W19]	■	-
White Diamond [W85]	-	■

## SEAT MATERIALS



Leather

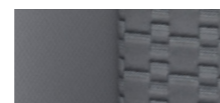

Fabric

	Titan	Barbarian
Fabric	■	
Leather (Black with orange stitching)		■

## L200 Specification Summary

Technical	Titan	Barbarian
Engine	4N16 4 Cylinder Bi-Turbo Diesel	■
Engine Size	2442cc	■
Fuel Type	Diesel	■
Body Type	Double Cab	■
Fuel Tank Capacity	75 Litres	■
Adblue Tank Capacity	17 Litres	■
Transmission	6 Speed Auto, Easy Select 4WD 6 Speed Auto, Super Select 4WD II	■
Safety & Security	Titan	Barbarian
ABS	■	■
Active Stability Control (ASC)	■	■
Active Traction Control (ATC)	■	■
Active Yaw Control (AYC)	-	■
Adaptive Cruise Control (ACC)	■	■
Air Bags x8 (Driver, Passenger, Central, Side, Curtain, Knee)	■	■
Automatic High Beam (AHB)	■	■
Blind Spot Warning (BSW)	■	■
Brake Assist System	■	■
Child Restraint - ISO-FIX	■	■
Chromic Mirror	-	■
Crash Detection Door Unlock	■	■
Day/Night Rearview Mirror	■	-
Driver Attention Alert (DAA)	■	■
Driver Monitoring System (DMS)	■	■
EBD (Electronic Brake Distribution)	■	■
Emergency Lane Assist (ELA)	■	■
Emergency Stop Signal System	■	■
Folding Wing Mirrors - Manual	■	-
Folding, Heated Wing Mirrors - Electric	-	■
Forward Collision Mitigation (FCM)	■	■
Front Cross Traffic Alert (FCTA)	■	■
Hill Descent Control	-	■
Hill Start Assist System	■	■
Immobiliser	■	■
Intelligent Speed Assist (ISA)	■	■
Lane Change Assist (LCA)	■	■
Lane Departure Prevention (LDP)	■	■
Lane Departure Warning (LDW)	■	■
Parking Sensors - Front & Rear	■	■
Rear Automatic Emergency Braking (Rear AEB)	■	■
Rear Cross Traffic Alert (RCTA)	■	■
Seatbelt Reminder Sensor - all seats	■	■
Speed Sensing Auto Door Lock	■	■
Traffic Sign Recognition (TSR)	■	■
Trailer Stability Assist System	■	■
Tyre Pressure Monitoring System (TPMS)	■	■

Comfort & Convenience	Titan	Barbarian
Auto Wipers	■	■
Carpet Flooring	-	■
Vinyl Flooring	■	-
Cup Holder For Front - 2pcs	■	■
Dual Zone Climate Control	-	■
Front Door Trim Illumination	-	■
Electric Window Switch Illumination All Doors	-	■
Electric Windows - Illuminated Switch On Drivers Door	■	-
Front Air Conditioning - A/C Auto	■	-
Gear Shift Control Knob - Leather	-	■
Glove Box - Lockable	■	■
Keyless Entry	■	■
Master Key x2 (Keyless Operation)	-	■
Master Key x2 (Manual Operation)	■	-
One Touch Start System	-	■
Rear Tailgate Assist	■	■
Steering Wheel - Leather	-	■
Sunglass Holder	■	■
Telescopic/Tilt Steering Column	■	■
Electrical	Titan	Barbarian
360 Degree Camera	■	■
9" Touch Display	■	■
Wireless Apple CarPlay	■	■
Android Auto	■	■
Bluetooth	■	■
DAB Radio	■	■
Speakers x4	■	-
Speakers x6	-	■
USB Front & Rear	■	■
Wireless Smartphone Charger	-	■
Exterior	Titan	Barbarian
Auto Lights with Auto High Beam	■	■
Front Skid Plate	■	■
Halogen Headlamps	■	-
LED Headlamps	-	■
Mud Guard (Front & Rear)	■	■
Roof Rails - Black	-	■
Spare Wheel	■	■
Seating	Titan	Barbarian
Fabric Seats	■	-
Leather Seats - Black With Orange Stitching	-	■
Heated Front Seats	-	■
Manual Seat Adjustment	■	-
Power Drivers Seat Adjustment	-	■

## L200 Technical Specification

Performance	Titan	Barbarian
Engine type	2.4L 4N16 Bi-Turbo Diesel	
Fuel type	Diesel	
Displacement (cc)	2,442	
Max power output - kW (PS) @ rpm	150 (204) @ 3,500	
Max torque - Nm (ft lb) @ rpm	470 (347) @ 1,500-2,750	
Acceleration 0-62 mph (secs)	12.6	
Maximum speed - mph (km/h)	111 (180)	
CO <sub>2</sub> Emissions and Energy Consumption		
WLTP - CO <sub>2</sub> - Weighted Combined - g/km	222	
WLTP - Fuel Consumption - Weighted Combined - mpg (l/100km)	33.3 (8.5)	
WLTP - Fuel Consumption - Low - mpg (l/100km)	25.6 (11)	
WLTP - Fuel Consumption - Medium - mpg (l/100km)	34.5 (8.2)	
WLTP - Fuel Consumption - High - mpg (l/100km)	39.7 (7.1)	
WLTP - Fuel Consumption - Extra High - mpg (l/100km)	31.9 (8.9)	
Weights/Volumes		
Gross vehicle weight (kg)	3,200	
Gross train weight (kg)	6,250	
Kerb weight (kg)	2,108	2,175
Max payload capacity (kg)	1,092	1,025
Maximum front axle load (kg)	1,580	
Maximum rear axle load (kg)	2,040	
Braked towing capacity (kg)	3,500	
Unbraked towing capacity (kg)	750	
Roof loading capacity (kg)	80	
Seating capacity	5	
Fuel tank capacity (l)	75	
Dimensions		
Exterior Length x Width x Height (mm)	5320 x 1865 x 1795	5320 x 1865 x 1815
Ground clearance - unladen (mm)	222	
Track width - Front / Rear (mm)	1570 / 1565	
Bed interior length x width x depth (mm)	1555 x 1545 x 526	
Cargo floor height (mm)	820	
Approach angle (°)	30.4	
Departure angle (°)	22.8	
Ramp breakover (°)	23.4	
Transmission		
Transmission type	6 Speed Automatic	
Suspension/Steering/Tyres		
Front suspension	High mounted double wishbone with coil spring & stabiliser bar	
Rear suspension	Leaf spring (heavy duty)	Leaf spring (Standard)
Drivetrain type	Part-time 4x4	Super Select 4WD II
Min. turning circle - diameter (m)	12.4	
Wheels	17" Alloy	18" Black Alloy
Tyres	265/65R17 112H	265/60R18 110H
Servicing/Warranty		
Servicing	10,000 miles/12 months	
Warranty	5 years, 62.5k miles	
Insurance Ratings		
Insurance Group	49D	49D

## L200 Dimensions

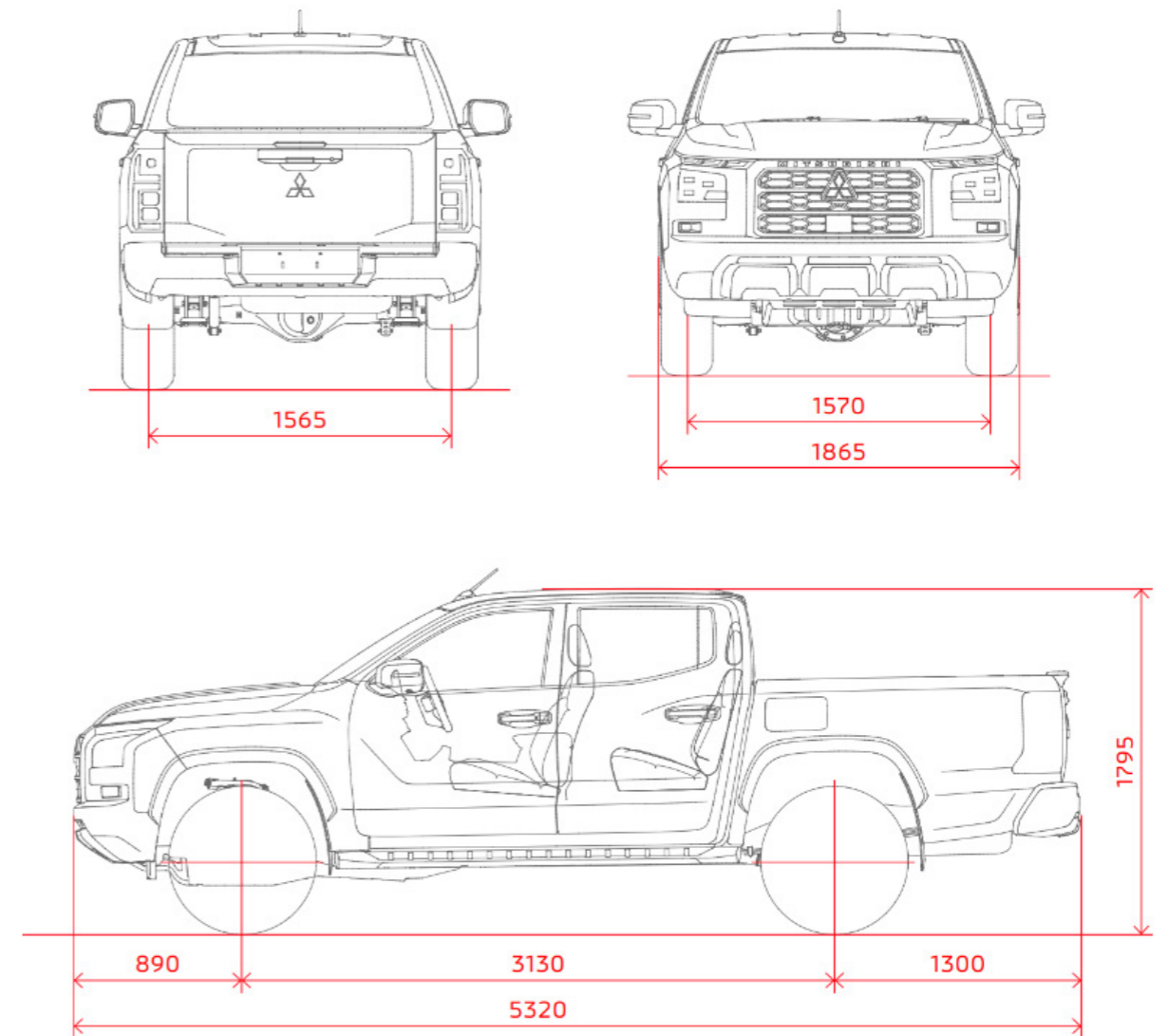

# L200



**MITSUBISHI  
MOTORS**

**Drive your Ambition**

Every effort has been made to ensure that the contents of this publication were accurate and up-to-date at the time of going to press. This brochure has been produced featuring prototype vehicles. The right is reserved to change specifications, part numbers and features without prior notice. Please consult your Mitsubishi Motors dealer for up-to-date information. Some of the products or vehicles shown in the brochure may differ from the models available in your market. The colours shown in this brochure may differ slightly from the actual colours of the paint and materials used due to printing process. All rights reserved. No part of this publication may be reproduced in any form or by any means, without the prior written permission of Mitsubishi Motors in the UK.

Mitsubishi Motors in the UK is a subsidiary of International Motors Ltd

